

D Faulgrube nach EN 12566-1
Carat S 3750 L mit Trennwand

Artikel-Nr.
article no.

GB Septic tank acc. EN12566-1
Carat S 3750L with baffle

ES

FR

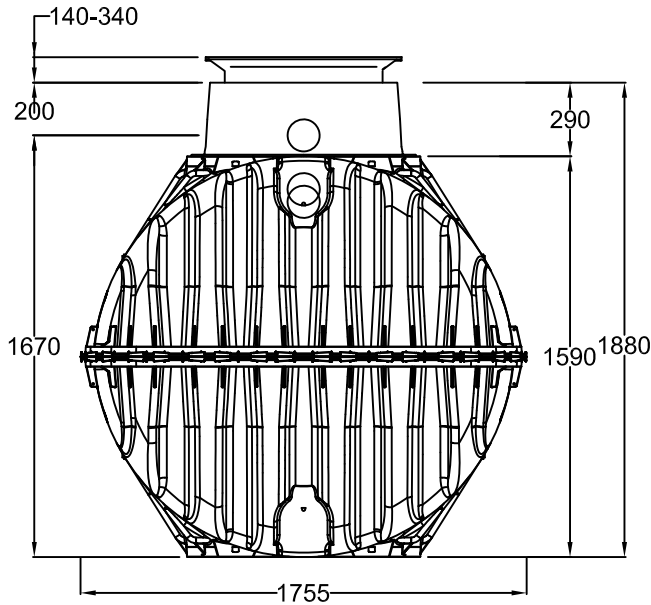
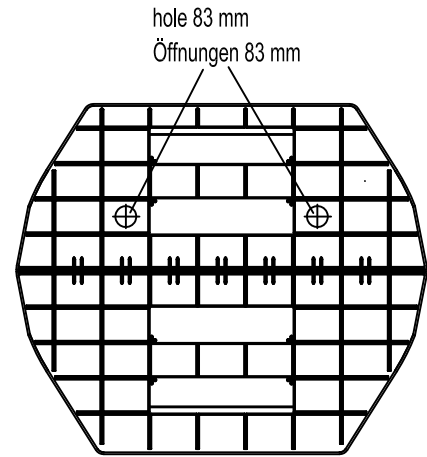
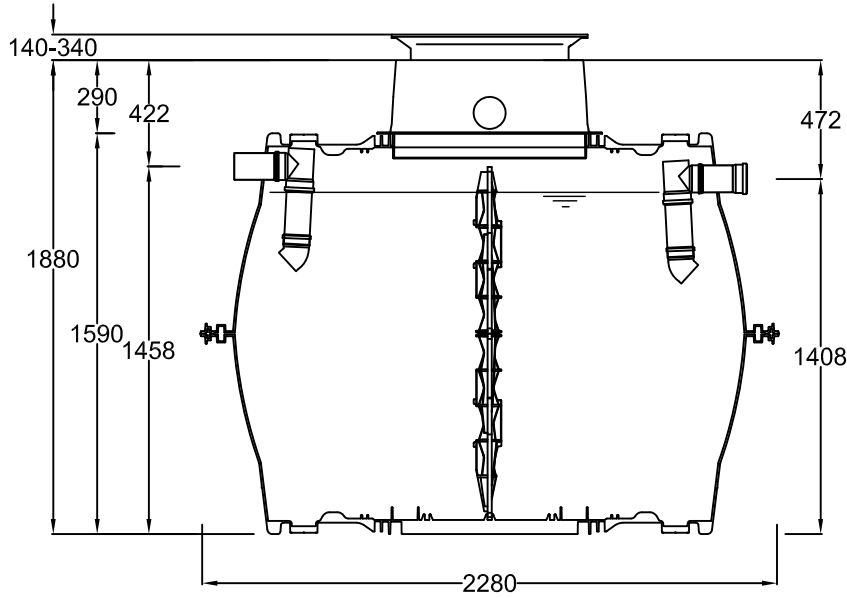

Otto Graf GmbH

Carl-Zeiss-Str. 2-6
DE-79331 Teningen
Germany
info@graf.info
www.graf.info

Zeichnungsinformation
drawing information

gezeichnet
drawn

CSC

Datum
date

04.07.2014

Toleranz
tolerance

+/- 3 %

Artikelinformation
article information

Gewicht
weight

Gewicht

Alle Maßangaben in mm
all dimension in mm